

FOOTING FOR USE IN ASPHALT. NOT REQUIRED IN CONCRETE.

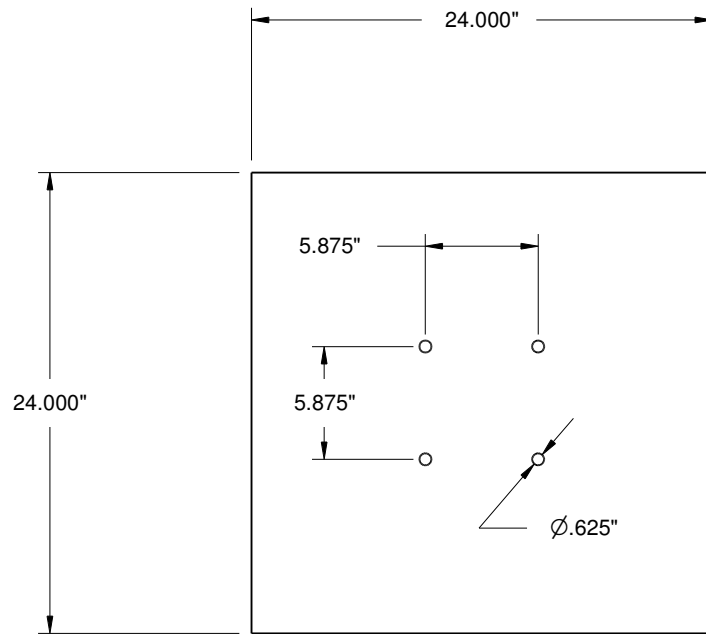

TOP

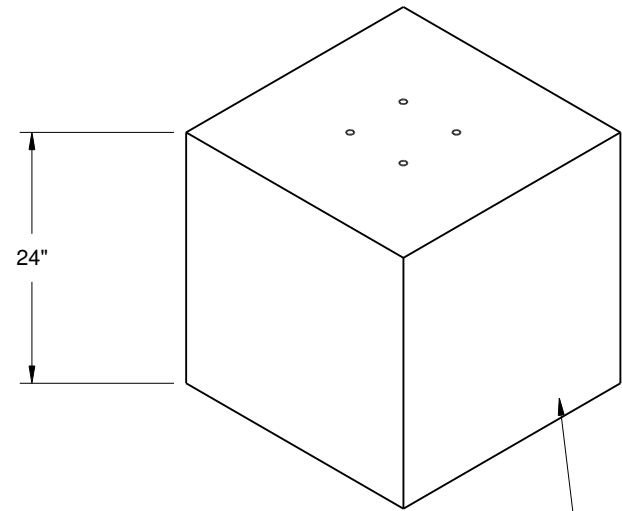

4000 PSI CONCRETE  
WITH #3 REBAR CAGE ON 6" CENTERS



**CONFIDENTIAL & PROPRIETARY**

The drawing on this print and the information therewith are property of SlowStop Guarding Systems, LLC, and shall not be used or discussed in whole or in part without the consent of SlowStop Guarding Systems, LLC.

4955 STOUT DR. · SAN ANTONIO, TX 78219 · (800) 736-5256

SIZE  
**A**

PART NO.

DWG.

**SLOWSTOP 3" FOOTING**

REV  
**1**

SCALE

SLOWSTOP GUARDING SYSTEMS, LLC

DATE 31-AUG-2017

FOOTING FOR USE IN ASPHALT. NOT REQUIRED IN CONCRETE.

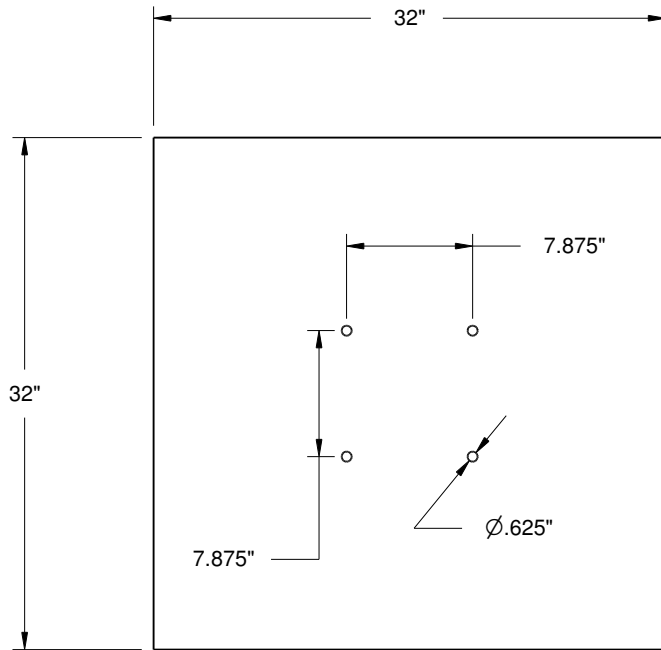

TOP

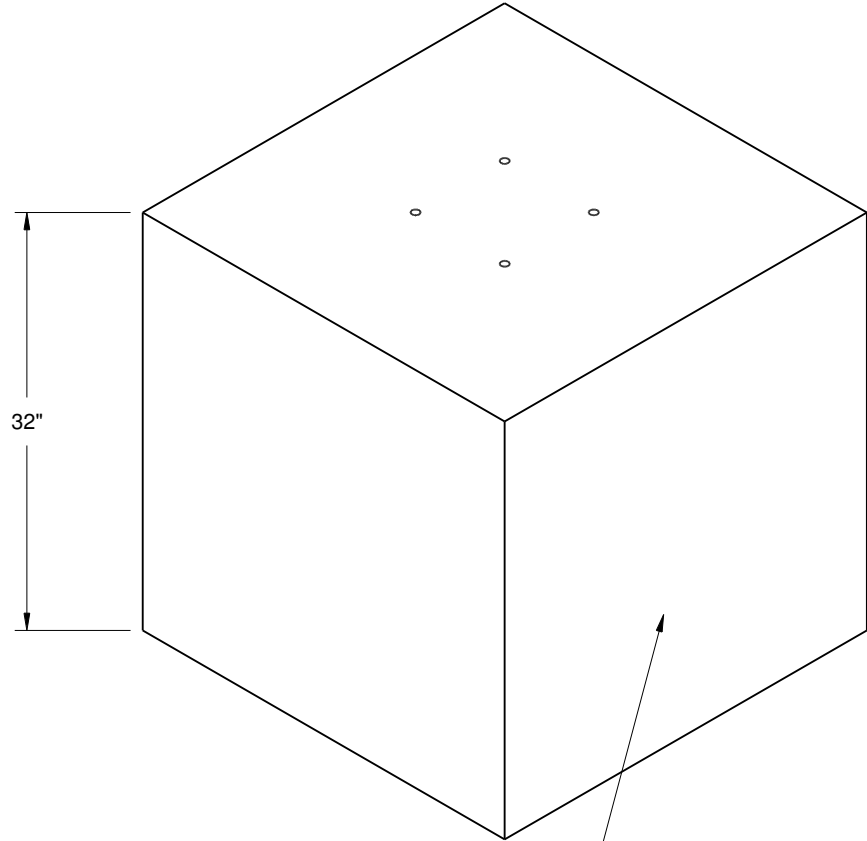

4000 PSI CONCRETE  
WITH #4 REBAR CAGE ON 6" CENTERS



CONFIDENTIAL & PROPRIETARY

The drawing on this print and the information therewith are property of SlowStop Guarding Systems, LLC, and shall not be used or discussed in whole or in part without the consent of SlowStop Guarding Systems, LLC.

4955 STOUT DR. · SAN ANTONIO, TX 78219 · (800) 736-5256

SIZE <b>A</b>	PART NO.	DWG. SLOWSTOP 4" FOOTING	REV <b>1</b>
SCALE	SLOWSTOP GUARDING SYSTEMS, LLC	DATE	31-AUG-2017

FOOTING FOR USE IN ASPHALT. NOT REQUIRED IN CONCRETE.

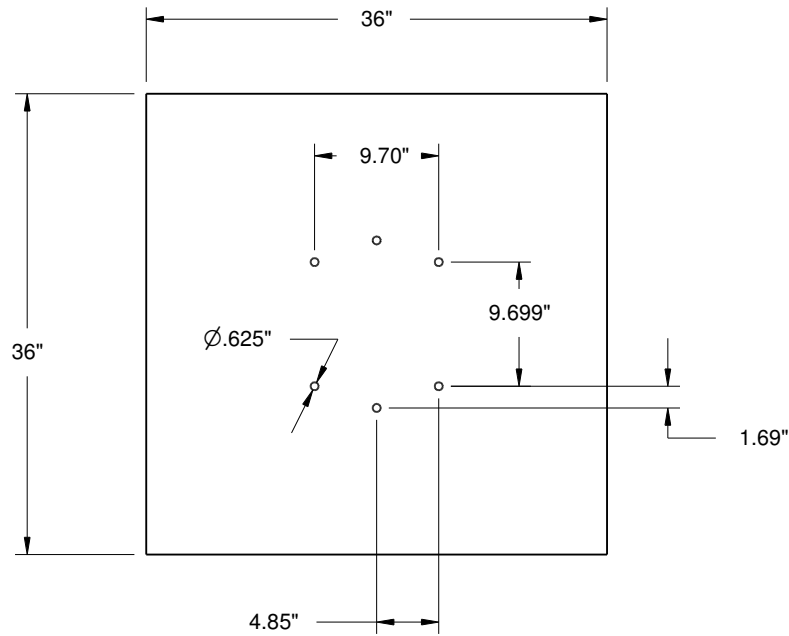

TOP

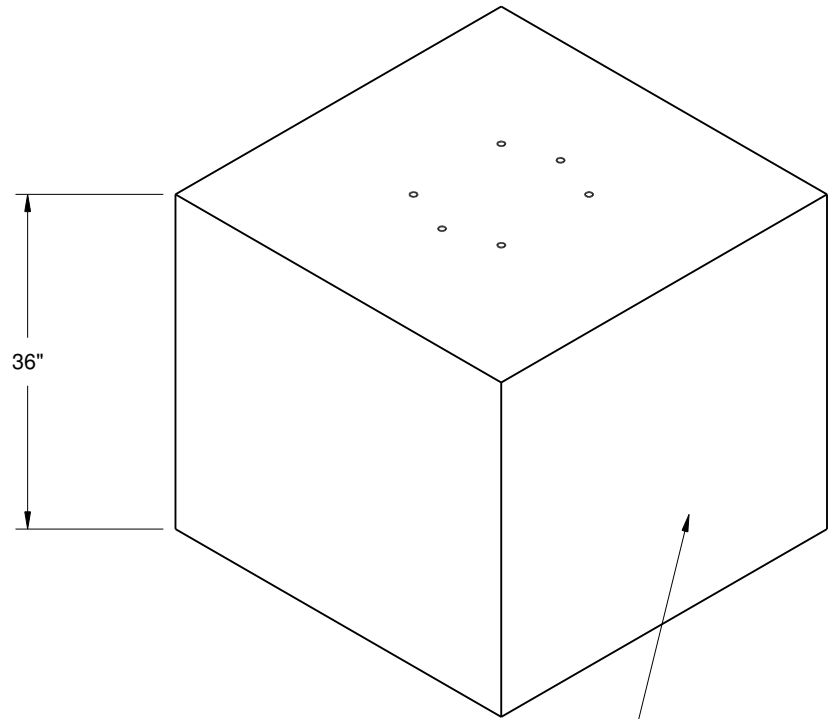

4000 PSI CONCRETE  
WITH #3 REBAR CAGE ON 6" CENTERS



CONFIDENTIAL & PROPRIETARY

The drawing on this print and the information therewith are property of SlowStop Guarding Systems, LLC, and shall not be used or discussed in whole or in part without the consent of SlowStop Guarding Systems, LLC.

4955 STOUT DR. · SAN ANTONIO, TX 78219 · (800) 736-5256

SIZE  
**A**

PART NO.

DWG.  
SLOWSTOP 5" FOOTING

REV  
**1**

SCALE

SLOWSTOP GUARDING SYSTEMS, LLC

DATE 31-AUG-2017

FOOTING FOR USE IN ASPHALT. NOT REQUIRED IN CONCRETE.

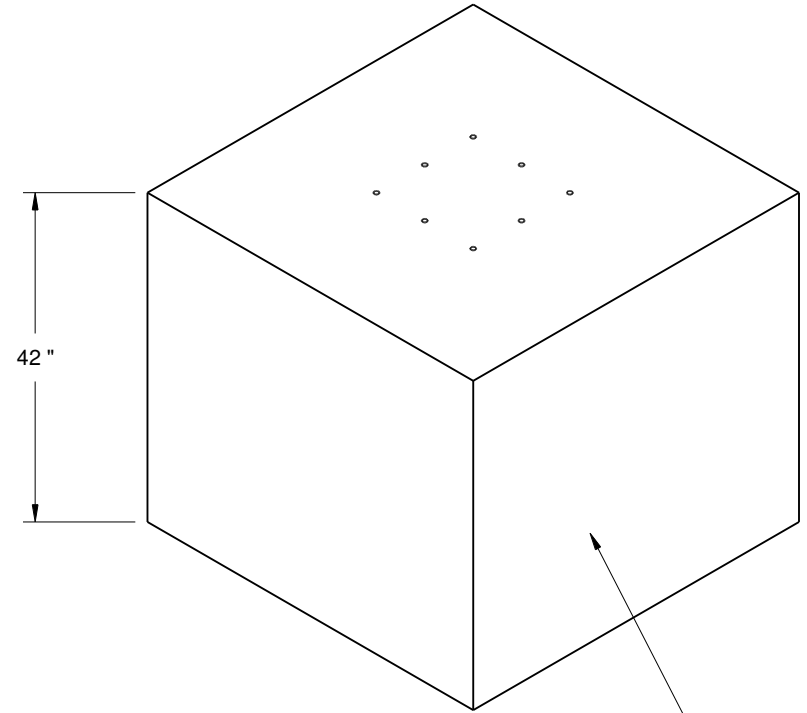
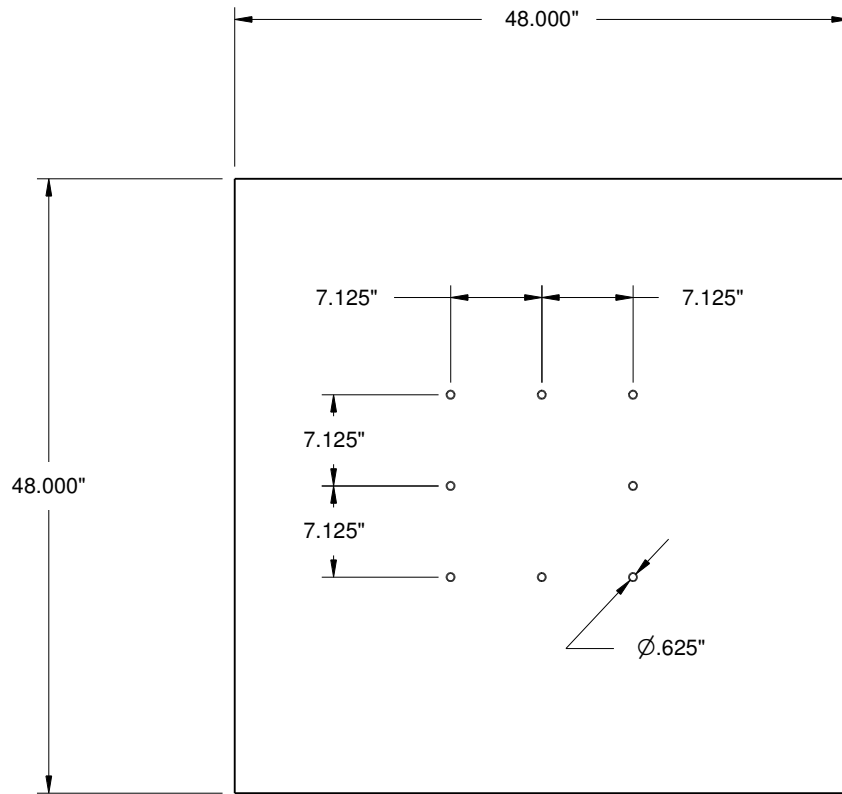

4000 PSI CONCRETE  
WITH #3 REBAR CAGE ON 6" CENTERS



**CONFIDENTIAL & PROPRIETARY**

The drawing on this print and the information therewith are property of SlowStop Guarding Systems, LLC, and shall not be used or discussed in whole or in part without the consent of SlowStop Guarding Systems, LLC.

4955 STOUT DR. · SAN ANTONIO, TX 78219 · (800) 736-5256

SIZE <b>A</b>	PART NO.	DWG. SLOWSTOP 6" FOOTING	REV 1
SCALE	SLOWSTOP GUARDING SYSTEMS, LLC	DATE	31-AUG-2017